

NEW !
IP 68 Protection

SPECIFICATIONS:

RATING: 12A 125/250VAC, 1/2HP 125VAC, 1HP 250VAC.
INSULATION RESISTANCE: DC 500V 100M-ohms min.
CONTACT RESISTANCE: DC 2-4V 1A 20m-ohms max.
DIELECTRIC STRENGTH: AC 1500V for 1 minute.

MATERIALS:

BUSHING: Zinc alloy.
BODY: Nylon 66.
ACTUATOR: Brass, nickel plated, anti-rotation.
ORING: Silicon gasket.
CONTACT: Silver alloy.
TERMINAL: Brass, tin plated.
NUT: Brass.
WASHER: Steel.
LOCKING RING: Steel.

Specifications and Dimensions subject to change

If your preferred product configuration is not shown, please contact our sales representative for custom design.

HOW TO ORDER SYSTEM

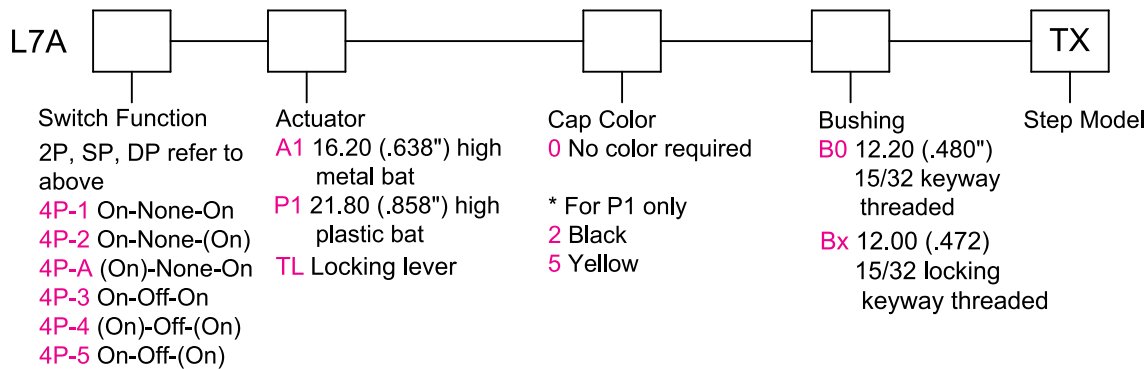
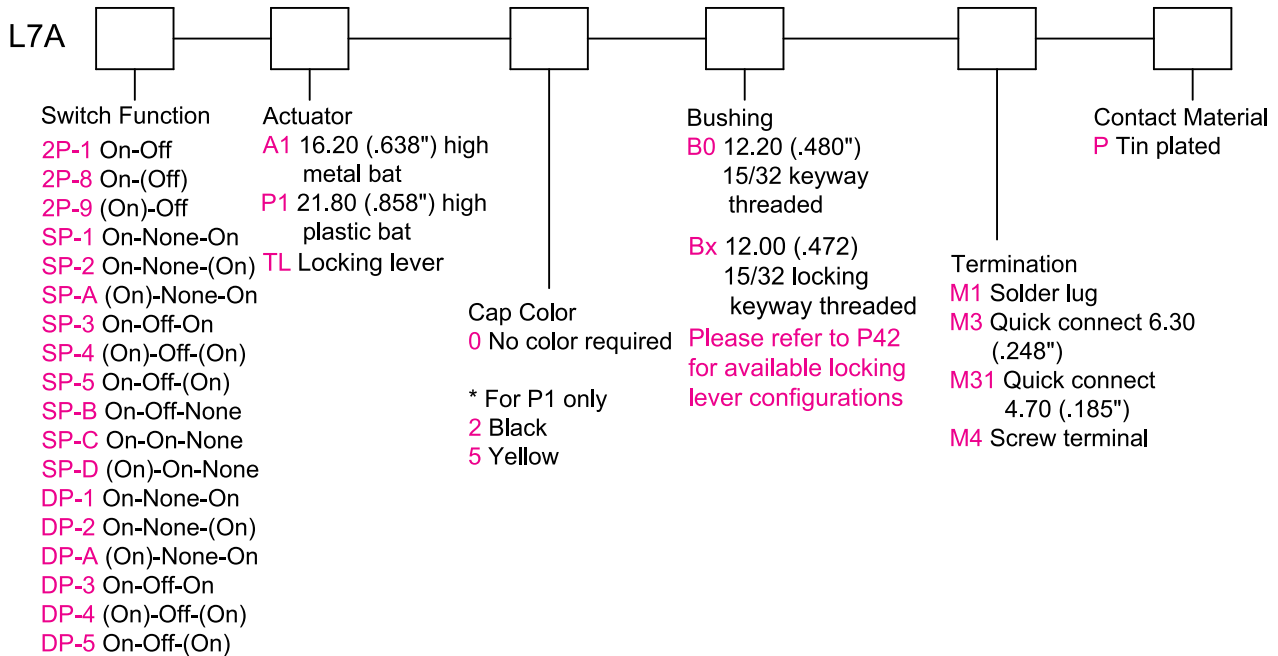

Series L7A

Sealed Power Toggle Switches

SPST



Model No.	Switching Position		
2P-1	ON	NONE	OFF
2P-8	ON	NONE	(OFF)
2P-9	(ON)	NONE	OFF
Term. Comm.	2-3	N/A	OPEN

Model No.	Switching Position		
2P-B	ON	OFF	NONE
Term. Comm.	2-3	OPEN	N/A

Schematic

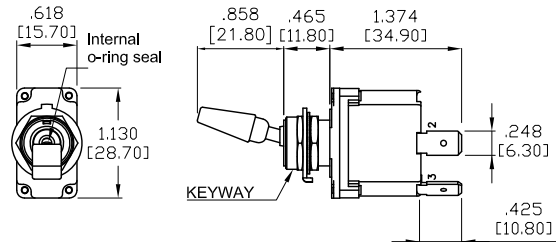
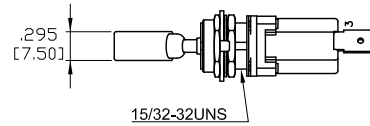

Remark:

For 2P-B model, the switch becomes 2-position with center being one extreme position.

SPDT



Model No.	Switching Position		
SP-1	ON	NONE	ON
SP-2	ON	NONE	(ON)
SP-A	(ON)	NONE	ON
SP-3	ON	OFF	ON
SP-4	(ON)	OFF	(ON)
SP-5	ON	OFF	(ON)
Term. Comm.	2-3	OPEN	2-1

Model No.	Switching Position		
SP-C	ON	ON	NONE
SP-D	(ON)	ON	NONE
Term. Comm.	2-3	2-1	N/A

Schematic

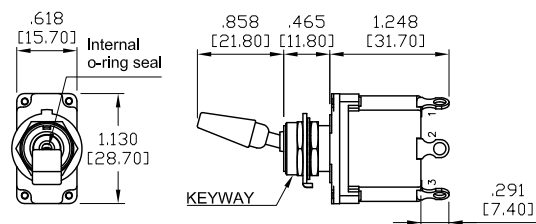
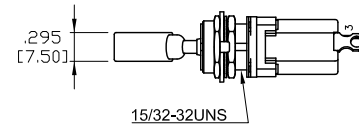

Remark:

For SP-C, SP-D models, the switch becomes 2-position with center being one extreme position.

DPDT



Model No.	Switching Position		
DP-1	ON	NONE	ON
DP-2	ON	NONE	(ON)
DP-A	(ON)	NONE	ON
DP-3	ON	OFF	ON
DP-4	(ON)	OFF	(ON)
DP-5	ON	OFF	(ON)
Term. Comm.	2-3, 5-6	OPEN	2-1, 5-4

Schematic

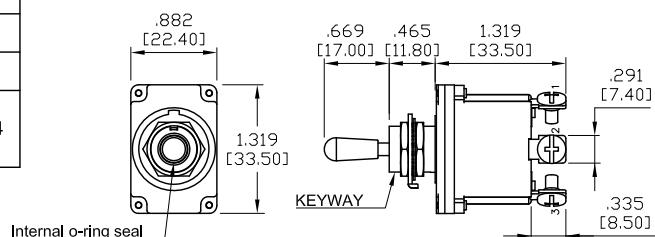
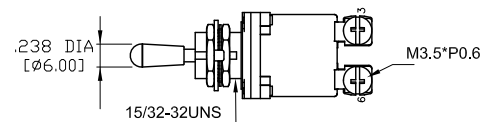
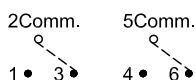

SPST



Model No.	Switching Position		
2P-1	ON	NONE	OFF
2P-8	ON	NONE	(OFF)
2P-9	(ON)	NONE	OFF
Term. Comm.	2-3	N/A	OPEN

Model No.	Switching Position		
2P-B	ON	OFF	NONE
Term. Comm.	2-3	OPEN	N/A

Schematic



STEP MODEL

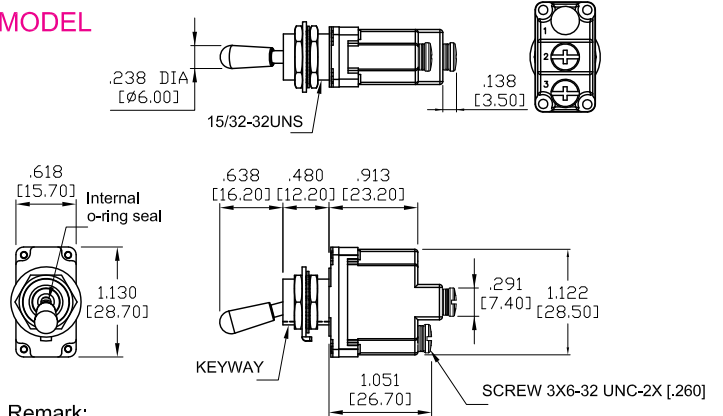

Remark:

For 2P-B model, the switch becomes 2-position with center being one extreme position.

SPDT



Model No.	Switching Position		
SP-1	ON	NONE	ON
SP-2	ON	NONE	(ON)
SP-A	(ON)	NONE	ON
SP-3	ON	OFF	ON
SP-4	(ON)	OFF	(ON)
SP-5	ON	OFF	(ON)
Term. Comm.	2-3	OPEN	2-1

Schematic



STEP MODEL

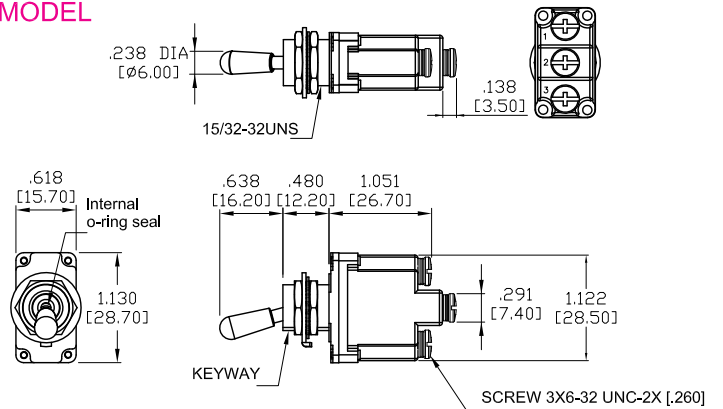

Remark:

For SP-C, SP-D models, the switch becomes 2-position with center being one extreme position.

DPDT



Model No.	Switching Position		
DP-1	ON	NONE	ON
DP-2	ON	NONE	(ON)
DP-A	(ON)	NONE	ON
DP-3	ON	OFF	ON
DP-4	(ON)	OFF	(ON)
DP-5	ON	OFF	(ON)
Term. Comm.	2-3, 5-6	OPEN	2-1, 5-4

Schematic

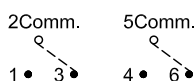

STEP MODEL

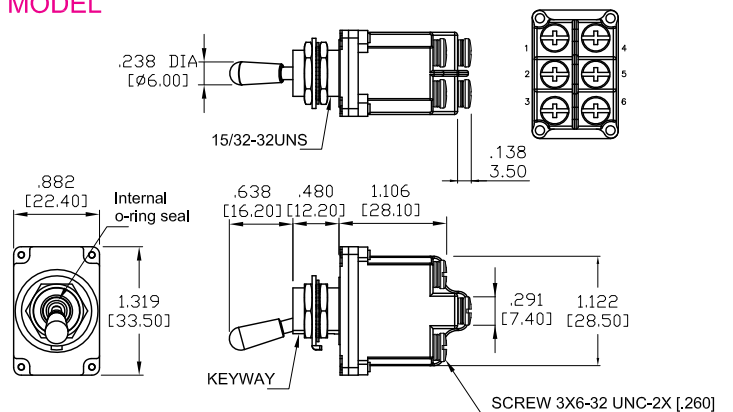

Series L7A

Sealed Power Toggle Switches

4PDT



Model No.	Switching Position		
4P-1	ON	NONE	ON
4P-2	ON	NONE	(ON)
4P-A	(ON)	NONE	ON
4P-3	ON	OFF	ON
4P-4	(ON)	OFF	(ON)
4P-5	ON	OFF	(ON)
Term. Comm.	2-3, 5-6 8-9, 11-12	OPEN	2-1, 5-4 8-7, 11-10

STEP MODEL

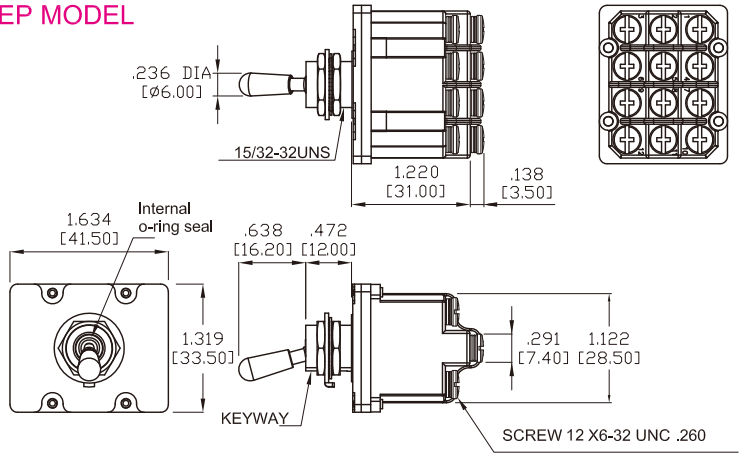

Schematic

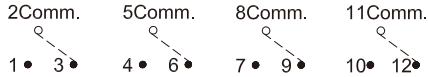

ACTUATOR OPTIONS

P1

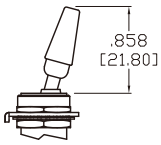

Cap Color	
2	Black
5	Yellow

MATERIAL: Nylon 6/6

A1

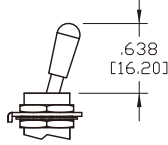

MATERIAL: Brass nickel plated

TL

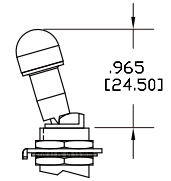

BUSHING OPTION

B0

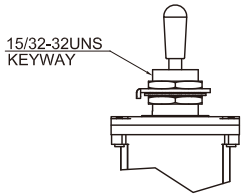

Bx

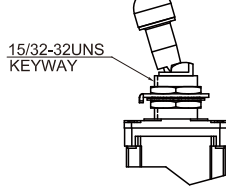

PANEL MOUNTING

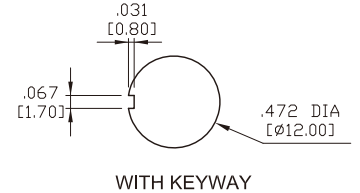
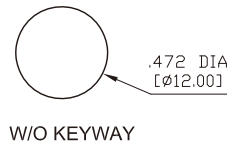

HARDWARE

NUT

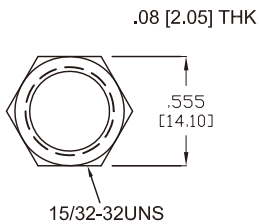

WASHER

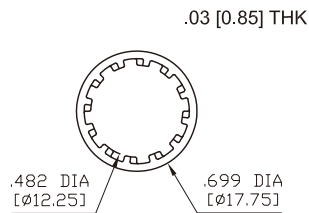

LOCKING RING

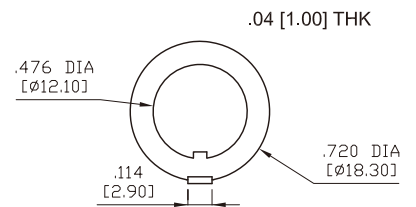

TERMINATION OPTIONS

M1

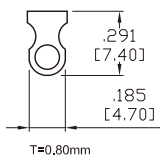

M3

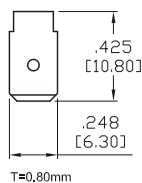



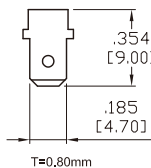



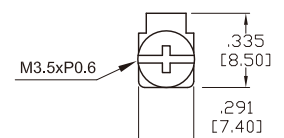





M31



M4



Locking Options				
Bushing Locking Type (Keyway on Left)	Keyway Side	Center Position	Opposite Keyway Side	Applicable Circuit
BA 	locked IN	locked IN	locked IN	ON-OFF-ON ON-ON-ON
BB 	locked IN	locked IN	locked OUT	ON-OFF-ON ON-ON-ON
BD 	locked IN	locked OUT	locked IN	ON-OFF ON-NONE-ON ON-OFF-ON ON-ON-ON
BE 	locked OUT	locked IN	locked OUT	ON-OFF-ON (ON)-OFF-(ON) ON-OFF-(ON) ON-ON-ON ON-ON-(ON) (ON)-ON-(ON) ON-OFF-NONE ON-ON-NONE (ON)-ON-NONE NONE-OFF-(ON)
BF 	locked OUT	locked OUT	locked IN	ON-OFF ON-(OFF) ON-NONE-ON OFF-(ON) ON-NONE-(ON) ON-OFF-ON ON-OFF-(ON) ON-ON-ON ON-ON-(ON) ON-OFF-NONE ON-ON-NONE
BG 	locked IN	locked OUT	locked OUT	ON-OFF ON-NONE-ON ON-OFF-ON ON-ON-ON
BH 	locked OUT	locked from Center to Keyway Side	locked IN	ON-OFF-ON ON-ON-ON
BJ 	locked IN	locked from Center to Opp. Keyway Side	locked OUT	ON-OFF-ON ON-ON-ON
BK 	locked OUT	locked IN	locked IN	ON-OFF-ON ON-OFF-(ON) ON-ON-ON ON-ON-(ON) ON-OFF-NONE ON-ON-NONE
BL 	locked OUT	locked from Center to Keyway Side	locked OUT	ON-OFF-ON (ON)-OFF-(ON) ON-OFF-(ON) ON-ON-ON ON-ON-(ON) (ON)-ON-(ON)
BM 	locked OUT	locked IN	locked IN	ON-OFF-ON ON-OFF-(ON) ON-ON-ON ON-ON-(ON) ON-OFF-NONE ON-ON-NONE
BN 	locked OUT	locked from Center to Opp. Keyway Side	locked OUT	ON-OFF-ON ON-OFF-(ON) (ON)-OFF-(ON) ON-ON-ON ON-ON-(ON) (ON)-ON-(ON)
BP 	locked IN	locked IN	locked OUT	ON-OFF-ON ON-ON-ON

- Toggle
- Rocker
- Slide
- Pushbutton
- AV
- Rotary
- Tact
- Touch Key
- Miscellaneous